

Varenummer: 201220457

Beskrivelse: E+G Magnet m/gevindbøsning GN 50.2-HF-40-M5
Hård ferrit - 200° C, 125N

Mål

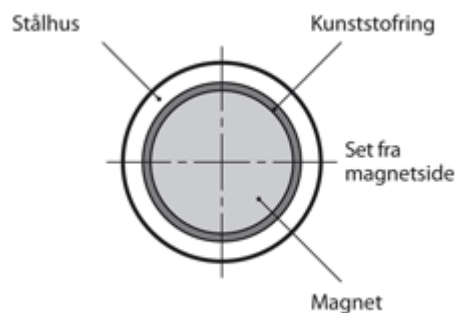

d1 = 40 +0,2/-0,1

d2 = M5x10

d3 = 10 ±0,1

h = 8 +0,4/-0,1

Holdekraft N = 125

Materiale = HF Hård ferrit - 200° C

t = 9